

INSTRUCTION MANUAL

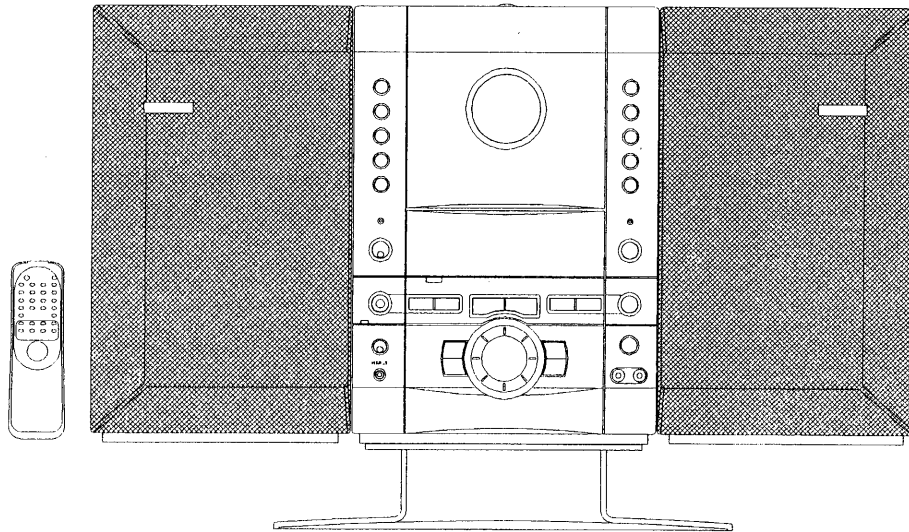

MODEL : SLIM-1500







3-PIECE SYSTEM

- Digital AM/FM Stereo Tuner
- CD Player
- Clock
- Wall Mountable
- Remote Control

FISHER'S HELP-LINE

Call the toll-free number below if you have difficulty operating this product.
1-800-421-6382 (weekdays 8:00 AM - 5:00 PM, Pacific Time)

SAFETY INFORMATION

	CAUTION: RISK OF ELECTRICAL SHOCK DO NOT OPEN	
CAUTION: TO REDUCE THE RISK OF ELECTRIC SHOCK, DO NOT REMOVE COVER. NO USER-SERVICEABLE PARTS INSIDE. REFER SERVICING TO QUALIFIED SERVICE PERSONNEL.		
	This symbol indicates that dangerous voltage constituting a risk of electric shock is present within this unit.	
	This symbol indicates that there are important operating and maintenance instructions in the literature accompanying this unit.	

- TO AVOID THE HAZARDS OF FIRE OR ELECTRICAL SHOCK, DO NOT EXPOSE THIS APPLIANCE TO RAIN OR OTHER MOISTURE.

SAFETY CERTIFICATION

This unit is made and tested to meet exacting safety standards. It meets CSA and FCC requirements and complies with safety performance standards of the U.S. Department of Health and Human Services.

CAUTION - USE OF CONTROLS OR ADJUSTMENTS OR PERFORMANCE OF PROCEDURES OTHER THAN THOSE SPECIFIED HEREIN MAY RESULT IN HAZARDOUS RADIATION EXPOSURE. THIS UNIT SHOULD NOT BE ADJUSTED OR REPAIRED BY ANYONE EXCEPT QUALIFIED SERVICE PERSONNEL.

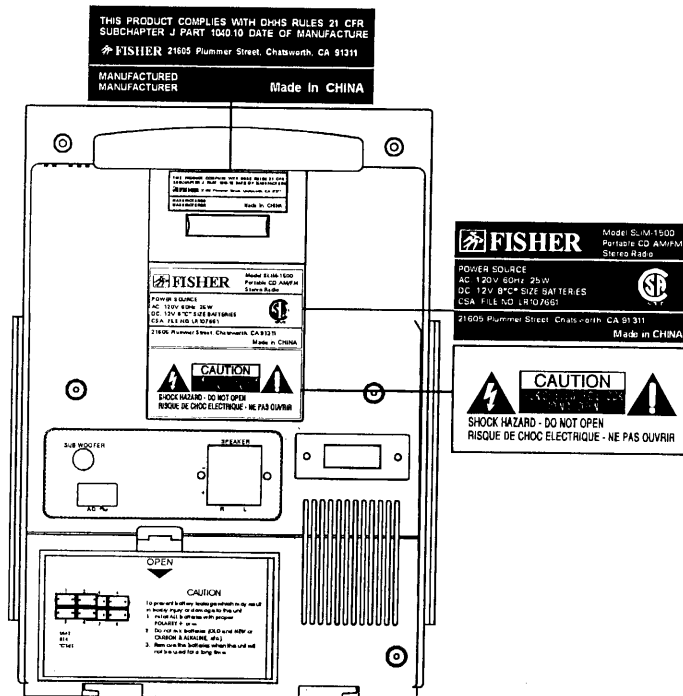

FCC INFORMATION

For CD player section: This device complies with Part 15 of the FCC Rules. Operation is subject to the following two conditions: (1) This device may not cause harmful interference, and (2) this device must accept any interference received, including interference that may cause undesired operation.

CAUTION:

Changes or modifications not expressly approved by Fisher may void the user's authority to operate this equipment.

NOTE:

This equipment has been tested and found to comply with the limits for a Class B digital device, pursuant to Part 15 of the FCC Rules. These limits are designed to provide reasonable protection against harmful interference in a residential installation. This equipment generates, uses and can radiate radio frequency energy and, if not installed and used in accordance with the instructions, may cause harmful interference to radio communications. However, there is no guarantee that interference will not occur in a particular installation. If this equipment does cause harmful interference to radio or television reception, which can be determined by turning the equipment off and on, the user is encouraged to try to correct the interference by one or more of the following measures:

- Reorient or relocate the receiving antenna.
- Increase the separation between the equipment and receiver.
- Connect the equipment into an outlet on a circuit different from that to which the receiver is connected.
- Consult the dealer or an experienced radio/TV technician for help.

FOR SAFE AND EFFICIENT OPERATION

- Do not damage the power cord.
- When not in use, disconnect the power cord from the outlet. Grasp the plug, not the cord, when disconnecting the unit.
- If water should enter the unit, electrical shock or a malfunction may result. Use in an area where there is low humidity and little dust.
- Do not disassemble or alter the unit in any way.
- Do not use the unit in areas where extremes in temperature occur (below 40°F or exceeding 95°F), or where it may be exposed to direct sunlight.
- Because of the CD player's extremely low noise and wide dynamic range, there is a tendency to turn the volume on the amplifier higher than necessary. Doing so may produce an excessively high output from the amplifier, which can cause damage to your speakers. Please be careful in this regard.
- Sudden changes in the surrounding temperature can cause dew to form on the optical pickup lens inside the unit. Under this condition, the unit may be unable to operate properly. If this should occur, remove the disc and allow the player to adjust to the surrounding temperature.

IMPORTANT SAFETY INSTRUCTIONS

1. Read Instructions - All the safety and operating instructions should be read before the product is operated.
2. Retain instructions - The safety and operating instructions should be retained for future reference.
3. Heed Warnings - All warnings on the product and in the operating instructions should be adhered to.
4. Follow Instructions - All operating and use instructions should be followed.
5. Cleaning - Unplug this product from the wall outlet before cleaning. Do not use liquid cleaners or aerosol cleaners. Use a damp cloth for cleaning.
6. Attachments - Do not use attachments not recommended by the product manufacturer as they may cause hazards.
7. Water and Moisture - Do not use this product near water-for example, near a bath tub, wash bowl, kitchen sink, or laundry tub; in a wet basement; or near a swimming pool; and the like.
8. Accessories - Do not place this product on an unstable cart, stand, tripod, bracket, or table. The product may fall, causing serious injury to a child or adult, and serious damage to the product. Use only with a cart, stand, tripod bracket, or table recommended by the manufacturer, or sold with the product. Any mounting of the product should follow the manufacturer's instructions, and should use a mounting accessory recommended by the manufacturer.
9. A product and cart combination should be moved with care. Quick stops, excessive force, and uneven surfaces may cause the product and cart combination to overturn.

PORTABLE CART WARNING
(symbol provided by RETAC)



S3125A

10. Ventilation - Slots and openings in the cabinet are provided for ventilation and to ensure reliable operation of the product and to protect it from overheating, and these openings must not be blocked or covered. The openings should never be blocked by placing the product on a bed, sofa, rug, or other similar surfaces. This product should not be placed in a built-in installation such as a bookcase or rack unless proper ventilation is provided or the manufacturer's instructions have been adhered to.
11. Power Sources - This product should be operated only from the type of power source indicated on the marking label. If you are not sure of the type of power supply to your home, consult your product dealer or local power company. For products intended to operate from battery power, or other sources, refer to the operating instructions.
12. Grounding or Polarization - This product may be equipped with a polarized alternating-current line plug (a plug having one blade wider than the other). This plug will fit into the power outlet only one way. This is a safety feature. If you are unable to insert the plug fully into the outlet, try reversing the plug. If the plug should still fail to fit, contact your electrician to replace your obsolete outlet. Do not defeat the safety purpose of the polarized plug.

Alternate Warnings - This product is equipped with a three-wire grounding-type plug, a plug having a third (grounding) pin. This plug will only fit into a grounding-type power outlet. This is a safety feature. If you are unable to insert the plug into the outlet, contact your electrician to replace your obsolete outlet. Do not defeat the safety purpose of the grounding-type plug.
13. Power-Cord Protection - Power-supply cords should be routed so that they are not likely to be walked on or pinched by items placed upon or against them, paying particular attention to cords at plugs, convenience receptacles, and the point where they exit from the product.
14. Lightning - For added protection for this product during a lightning storm, or when it is left unattended and unused for long periods of time, unplug it from the wall outlet and disconnect the antenna or cable system. This will prevent damage to the product due to lightning and powerline surges.

15. Outdoor Antenna Grounding - If an outside antenna or cable system is connected to the product, be sure the antenna or cable system is grounded so as to provide some protection against voltage surges and built-up static charges. Article 810 of the National Electric Code, ANSI/NFPA 70, provides information with regard to proper grounding of the mast and supporting structure, grounding of the lead-in wire to an antenna discharge unit, size of grounding conductors, location of antenna-discharge unit, connections to grounding electrodes, and requirements for the grounding electrode. (See Figure 2)

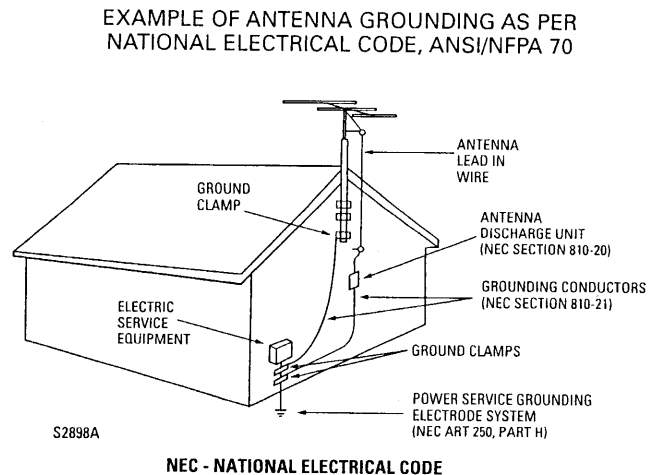

(Figure 2)

16. Power Lines - An outside antenna system should not be located in the vicinity of overhead power lines or other electric light or power circuits, or where it can fall into such power lines or circuits. When installing an outside antenna system, extreme care should be taken to keep from touching such power lines or circuits as contact with them might be fatal.

17. Overloading - Do not overload wall outlets, extension cords, or integral convenience receptacles as this can result in a risk of fire or electric shock.
18. Object and Liquid Entry - Never push objects of any kind into this product through openings as they may touch dangerous voltage points or short-out parts that could result in fire or electric shock. Never spill liquid of any kind on the product.
19. Servicing - Do not attempt to service this product yourself as opening or removing covers may expose you to dangerous voltage or other hazards. Refer all servicing to qualified service personnel.
20. Damage Requiring Service - Unplug this product from the wall outlet and refer servicing to qualified service personnel under the following conditions:
- a. When the power-supply cord or plug is damaged.
 - b. If liquid has been spilled, or objects have fallen into the product.
 - c. If the product has been exposed to rain or water.
 - d. If the product does not operate normally by following the operating instructions. Adjust only those controls that are covered by the operating instructions as an improper adjustment of other controls may result in damage and will often require extensive work by a qualified technician to restore the product to its normal operation.
 - e. If the product has been dropped or damaged in any way.
 - f. When the product exhibits a distinct change in performance. -This indicates a need for service.
21. Replacement Parts - When replacement parts are required, be sure the service technician has used replacement parts specified by the manufacturer or have the same characteristics as the original part. Unauthorized substitutions may result in fire, electric shock, or other hazards.
22. Safety Check - Upon completion of any service or repairs to this product, ask the service technician to perform safety checks to determine that the product is in proper operating condition.
23. Heat - The product should be situated away from heat sources such as radiators, heat registers, stoves, or other products (including amplifiers) that produce heat.

POWER SUPPLY

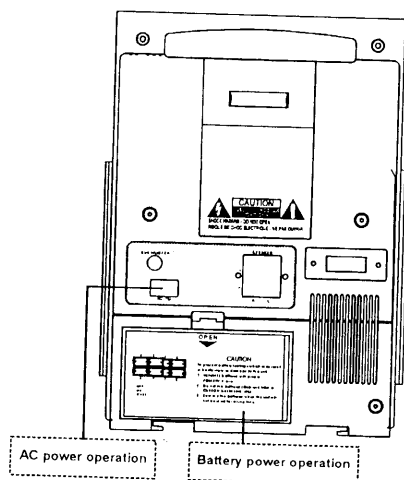

Take the cord out and connect it.

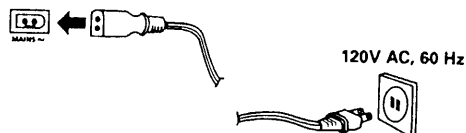

NOTE:

- This unit is equipped with a polarized plug. If you have difficulty inserting the plug, turn it over and reinsert it.
- When the AC power cord is connected to the unit, the installed batteries will be automatically disconnected.

Install batteries (not supplied).
Observe + and - signs.

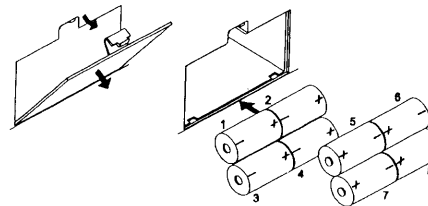

Remember to replace the battery compartment lid
8 "C" size batteries

CAUTION:

WHEN INSTALLING THE BATTERIES

To prevent leakage from the batteries, which is corrosive and can cause personal injury and damage to the unit, observe the following precautions:

1. The batteries must be installed correctly. Match the polarities(+ and -signs) on the batteries, to the polarities shown on the back of the unit (see above).
2. Do not mix new batteries with old or used batteries.
3. Only use batteries of the same type and brand.
4. If the unit will not be used for an extended period of time, remove the battery and store them in a cool place.
5. Carefully follow the battery manufacturer's instructions for proper use and disposal.
6. DO NOT ALLOW YOUNG CHILDREN TO HANDLE BATTERIES.

IMPORTANT NOTE:

SPENT OR DISCHARGED BATTERIES MUST BE RECYCLED OR DISPOSED OF PROPERLY IN COMPLIANCE WITH ALL APPLICABLE LAWS. FOR DETAILED INFORMATION, CONTACT YOUR LOCAL COUNTRY SOLID WASTE AUTHORITY.

LOCATION OF CONTROLS

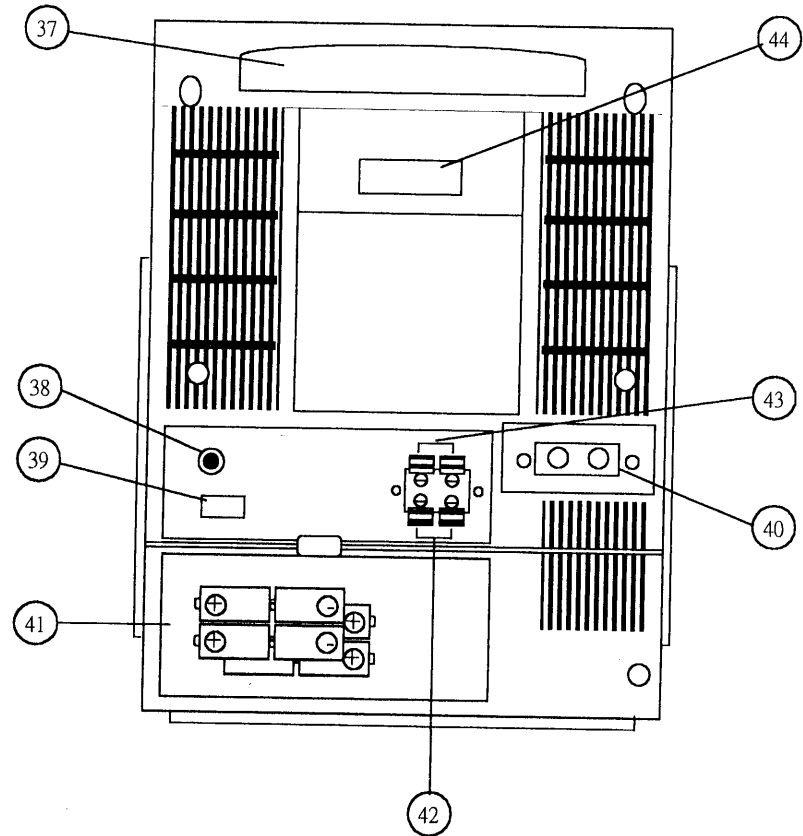
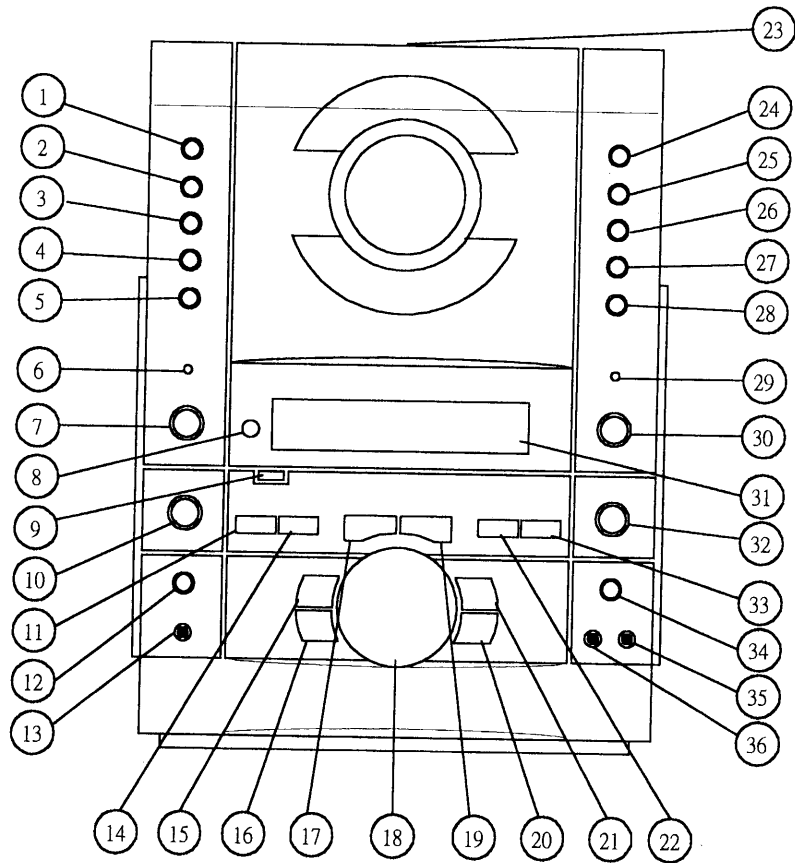

LOCATION OF CONTROLS (cont. .)

- 1. SNOOZE Button**
Press the SNOOZE button to turn off the sound temporarily (for about 5 minutes). (Operates in conjunction with the wake-up timer.)
- 2. SLEEP Button**
Press for "sleep to Radio or CD."
- 3. TIMER button**
Press to set wake-up and shut-off time.
- 4. PRESET / REPEAT button**
TUNER - Press to retrieve radio station memories presets.
CD - Press to repeat one or all tracks while a CD plays.
- 5. MEMORY button**
TUNER - Press to preset stations.
CD - Press to program tracks.
CLOCK - Press to set hours and minutes.
- 6. POWER Standby Indicator**
This indicator lights when AC power cord is connected properly or fresh batteries are installed and unit is OFF.
- 7. POWER On/Off Button**
Press to turn the power ON or OFF-Standby.
- 8. REMOTE Control Sensor**
Receives infrared data signals from the remote control.
- 9. BACKLIGHT On/Off Button**
Press this button to turn LCD display backlight on or off.
Note: When on battery operation, LCD backlight should be used sparingly to conserve power.
- 10. SURROUND button**
Press to turn the surround sound ON or OFF.
- 11. MONO / STEREO button**
Press to select mono or stereo from FM stations.
- 12. MUTE button**
Press to temporarily reduce listening volume.
- 13. HEADPHONE Jack**
Connect a pair of stereo headphones (not supplied) for private listening
- 14. CD INTRO button**
Press to play or release the intro mode.
- 15. BASS / + button**
Press to increase the bass level.
- 16. BASS / - button**
Press to reduce the bass level.
- 17. CD / TUNING / CLOCK downward setting button**
CD - Press to skip/search backward.
TUNER - Press to radio stations scan downward.
CLOCK or TIMER - Press select the time downward while setting the clock or timer.
- 18. VOLUME Control knob**
Turn left or right to adjust sound level up or down.

LOCATION OF CONTROLS (cont. .)

- 19. CD / TUNING / CLOCK forward setting button**
CD - Press to skip/search forward.
TUNER - Press to radio stations scan forward.
CLOCK or TIMER - Press select the time forward while setting the clock or timer.
- 20. TREBLE / - button**
Press to reduce treble sound level.
- 21. TREBLE / + button**
Press to increase treble sound level.
- 22. CD PLAY/PAUSE Button (▶||)**
Press to begin CD play, to stop temporarily or to scan tuner memory presets.
- 23. CD door open button**
Press to open the CD door.
- 24. TUNER select button**
Press to set the unit to Tuner mode.
- 25. CD select button**
Press to set the unit to CD mode.
- 26. LINE select button**
Press to set the unit to Line mode.
- 27. BAND button**
Press to select AM or FM band.
- 28. MODE / REMAIN button**
CLOCK - Press mode to set clock time, wake-up or shut-off time.
TUNER - Press mode to select clock time, wake-up or shut-off time or radio frequency.
CD - Press remain to display the remaining time.
- 29. SUREWAKE indicator**
This indicator lights while surewake function is ON.
- 30. SUREWAKE button**
Press to turn ON the SureWake function.
- 31. LCD display**
Shows the operating status in all modes.
- 32. DYNAMIC BASS button**
Press to turn the super bass ON or OFF.
- 33. CD STOP button**
Press to stop CD play.
- 34. IN - LINE - OUT button**
Press to select Line In or Line Out while in Line select mode.
- 35 & 36. Left and Right jack**
Connect with other external musical instruments to perform AUX IN or AUX OUT functions.
- 37. Carrying Recess**
- 38. Sub Woofer Jack**
To connect with external sub woofer speaker (not included).
- 39. AC input socket**
To connect the AC cord plug into the socket.
- 40. FM Antenna Terminal**
Connect single antenna wire (supplied) to terminal marked 75Ω or dipole antenna (not supplied) to terminals marked 300Ω
- 41. Battery compartment**
Install eight "C" size batteries according to the polarity diagram inside the battery compartment. Alkaline type is recommended.

LOCATION OF CONTROLS (cont. .)

42. Left channel speaker terminal

Connect the left speaker cable here.

43. Right channel speaker terminal

Connect the right speaker cable here.

44. Slot for Wall-Mounting Bracket

Used to connect the mounting (included) to mount the unit on the wall.

REMOTE CONTROL

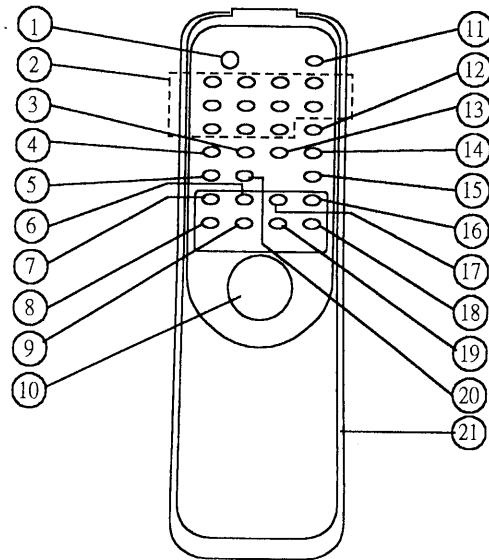

1. Power ON/OFF-Standby button
2. Program select buttons
Tuner - To recall preset stations.
CD - To recall tracks.
For 1 - 9, press 1 - 9 buttons.
For 10, press 10+ and then "0".
For 11 - 19, press 10+ once then 1 - 9.
For 20, press 10+ twice and then "0".
For 21 - 29, press 10+ twice then 1 - 9.
For 30, press 10+ three times and then "0".
3. MEM: CD - Use to program CD tracks for programmed play / TUNER - Use to programmed preset memory
4. RANDOM: CD Random play
5. TIMER: Press to switch ON or OFF Timer function
6. TUNER: Press to select the Tuner mode
7. SLEEP: Press to select the sleep
8. CD - Skip/Search backward / TUNER - Tuning down
9. CD - Skip/Search forward / TUNER - Tuning up
10. VOLUME: Volume up or down
11. MUTE: Muting ON/OFF
12. INTRO: CD Intro play
13. REPEAT/PRESET: CD - Repeat play / Tuner - To select Preset station
14. REMAIN/MODE: CD - Check the remaining and clock time / TUNER - Check clock and frequency
15. LINE: Press to select the Line in or Line out functions
16. CD: Press to select the CD function
17. BAND: Press to select AM/FM band in Tuner mode
18. PLAY/PAUSE: CD Play/Pause
19. STOP: CD Stop
20. Snooze button
21. Battery Compartment

INSTALLATION

Installation options:

- wall mount
- shelf placement
- one or both speakers attached or detached

To mount the center section on the wall:

- Position the bracket on the wall (as shown below) where you want to hang the center unit. Drill 2 holes slightly undersized for a firm fit.
- Secure the bracket on the wall using 2 dowels and 2 screws (supplied)
- Mount the center unit onto the wall bracket. Make sure the mounting tab on the center unit fits securely into the mounting slot on the wall bracket.
- Screws and plastic dowels are also provided for speakers if they are to be wall-mounted away from the center section.

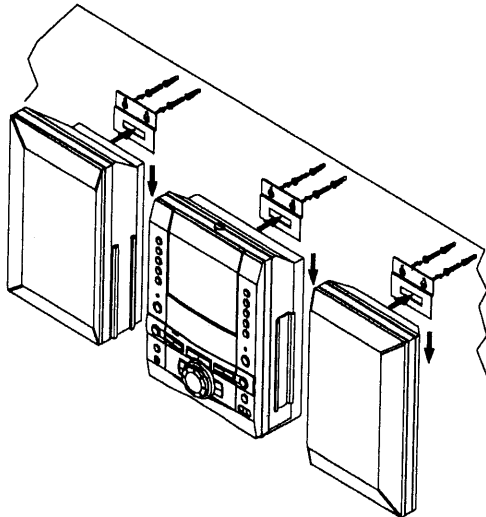

To install center section on a table or shelf:

Insert the base from the back of the unit, push until it clicks into position.

To connect the speakers with the center section:

Attach left and right speakers to the center section by sliding down each speaker straight along the side of the center section cabinet.

Connect the left/right speaker lead wires to the speaker terminals. Pay attention to the polarity. The polarity wires (gray wire with black stripe) should connect to the red color terminals.

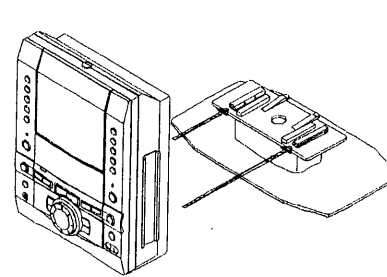

TO ATTACH THE MAIN UNIT TO THE BASE

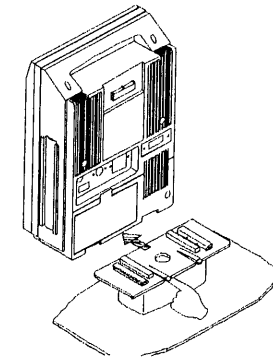

TO RELEASE THE MAIN UNIT FROM THE BASE

GENERAL OPERATION

Power on

When power is connected for the first time, or if the power card was unplugged and reconnected:

1. The STANDBY LED lights, and the LCD panel appears as follows

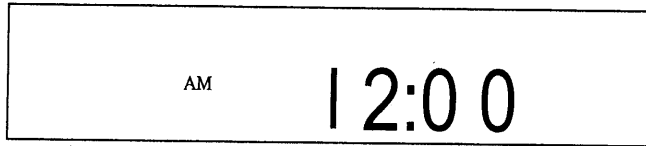

2. Press the **POWER** button. The STANDBY LED turns off and the unit defaults to the tuner function, FM band, #1 preset memory, minimum volume.

Afterward, when the **POWER** is turned on, the previously chosen function will be selected.

To set the clock

1. Press the **POWER** button to turn the unit off "standby".
2. Press the **MEMORY** button ONCE. The Minute segments display "00". The Hour segments flash continuously
Note: Be sure to pay attention to the "AM" or "PM" setting.

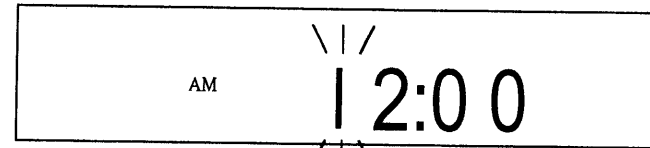

3. Press the **CD-TUNING-SKIP** + or - button to select the desired hour.
4. Press the **MEMORY** button again and the minute segments flash.

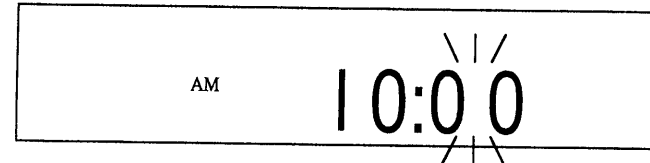

5. Press the **CD-TUNING-SKIP** + or - button to select the desired minute
6. Press the **MEMORY** button once more. The flashing stops and the time is set.

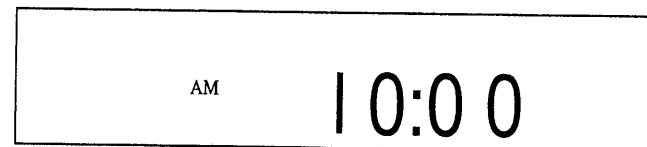

CD OPERATION

Basic operation

1. Press **POWER** button to turn on the power.
2. Open the CD door, then load the Disc with the label side up and press it onto the spindle until it "CLICKS " on the central support of the compartment. Close the door.

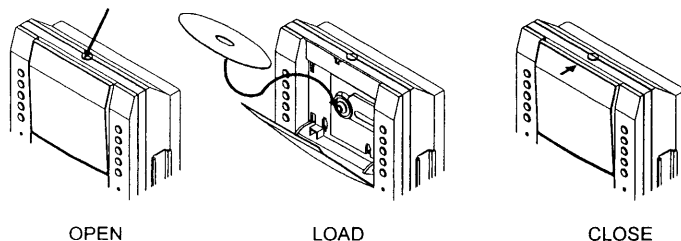

- Step 1 - Push the CD door open button to open CD door.
 Step 2 - Loading disc as shown.
 Step 3 - Be sure that disc is located in proper position.
 Step 4 - Push CD door close

3. The disc will spin and the unit will read and display the number of tracks and the total recorded time. Press the play/pause button once. The display will show the first track number on the disc, then indicate the elapsed time as shown below, and play will start.

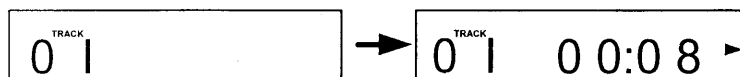

4. If there is no disc in the CD compartment and the CD button is pressed, the LCD will show "no disc."

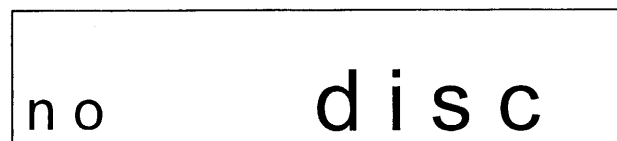

5. Adjust the VOLUME control to a comfortable level.
6. Press and release the **CD-TUNING-SKIP** + or - button to skip to the desired track.
7. Press and hold the **CD-TUNING-SKIP** + or - button to search for the desired section within a track.
8. Press the **▶||** button to pause temporarily. The LCD will appear as shown below:

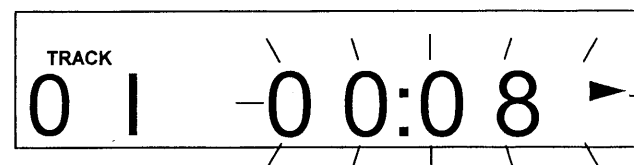

Press **▶||** again to resume.

9. Press the **STOP** button to stop playing. The display will show the total number of tracks and the playing time of the disc.

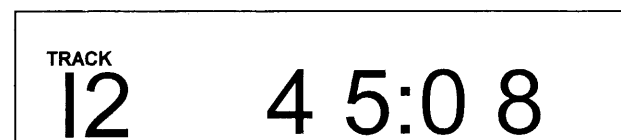

CD OPERATION (cont.)

To begin program play

The CD player can be programmed to play up to 20 tracks in the order desired.

1. Press **POWER** button to turn on the power, then load a disc
2. Press the **MEMORY** button repeatedly until the LCD appears as follows:

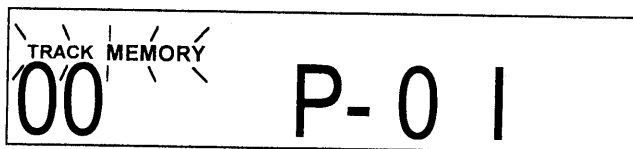

3. Press the **CD-TUNING-SKIP** + or - button to select the desired track to be programmed.
4. Press the **MEMORY** button to store the selection.

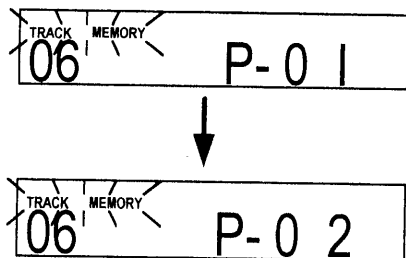

5. Repeat steps 3-4 to program additional tracks up to a maximum of 20 tracks.
6. While display showing tracks programmed, press the **▶||** button. the CD player will play the tracks in the order they were programmed.

Note: The display will return to show the total number of tracks and the playing time of the disc if no further tracks program during "TRACK" and "MEMORY" flashing.

7. Press the **CD-TUNING-SKIP** button to skip forward or backward through programmed tracks.
8. Any one of the following actions will cancel program play mode,
 - Select another function (TUNER, LINE),
 - Press the **STOP** button twice, then press the **▶||** button,
 - Open the CD door or
 - Turn off the power.

CD OPERATION (cont.)

To begin random play

1. Press the **RANDOM** button by Remote Handset, the "RANDOM" indicator appears on the LCD.

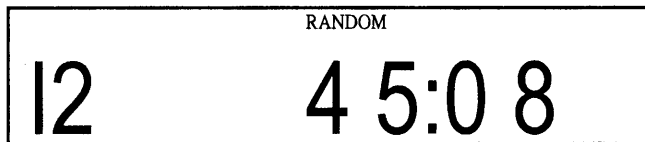

2. Press the **▶||** button.
3. To cancel random play, press the **RANDOM** button to change to another mode.

To begin repeat play

1. Press the **REPEAT** button once and all tracks will play repeatedly. The "REPEAT" indicator appears on the LCD.

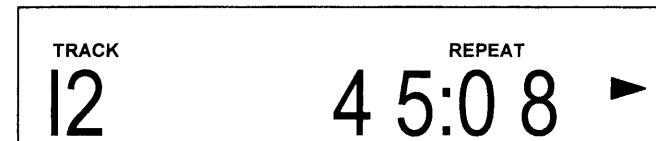

2. Press the **REPEAT** button again and the selected track will play repeatedly. The "REPEAT" indicator flashing on the LCD.

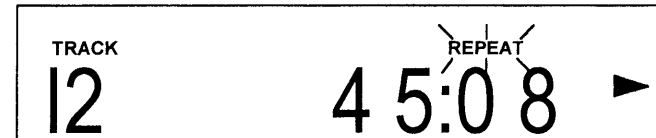

3. Press the **REPEAT** button once more to cancel the repeat mode.

TUNER OPERATION

Basic operation

1. Press **POWER** button to turn on the power.
2. Press the **TUNER** button and press the **BAND** button to select AM or FM.

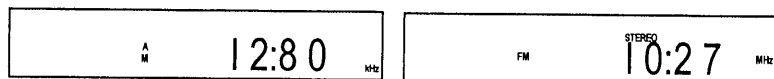

3. Press and release the **CD-TUNING-SKIP +** or **-** button to select the desired radio station.
4. Press and hold the **CD-TUNING-SKIP +** or **-** button briefly to search up or down for the next receivable station.

To store favorite stations in memory

You can store up to 20 FM and 20 AM stations in memory.

1. Select the desired radio station as described above.
2. Press the **MEMORY** button. The **MEMORY** indicator flashes on LCD.

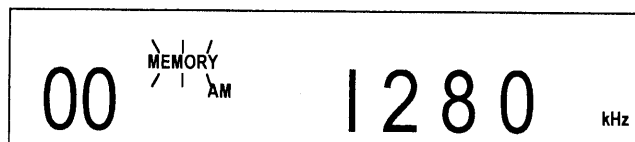

3. Press the **PRESET / REPEAT** button to assign the present number.

For example, to store a particular radio station on preset #19, you can press the **PRESET / REPEAT** button 19 times

The LCD shows the preset number.

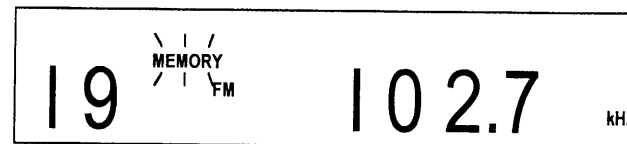

4. Press the **MEMORY** button to store the selection. The **MEMORY** indicator stop flashing.
5. Repeat steps 3 and 4 to store additional radio stations in memory.

TIMER OPERATION

To set the wake-up timer

1. Press the power button to turn the unit off "STANDBY". Press **MODE / REMAIN** button. The **TIMER ON** indicator appears on the LCD and flashes. Press **MEMORY** button the hour segment flashes.

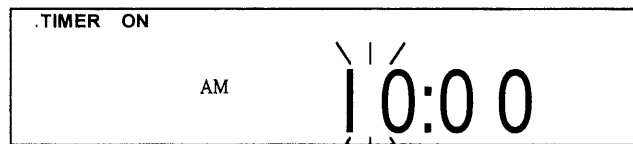

2. Press the **CD-TUNING-SKIP** button to select the wake-up hour.
3. Press the **MEMORY** button again. The hour segment stops flashing, the minute segment flashes.

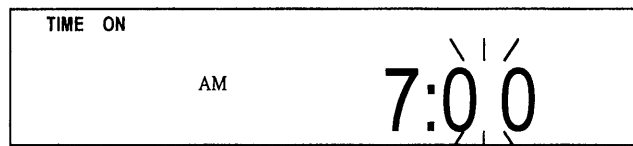

4. Press the **CD-TUNING-SKIP** button to select the wake-up minute.
5. Press the **MODE / REMAIN** button once. The **TIMER OFF** indicator appears and flashing on the LCD. Press **MEMORY** button the hour segment flashes.

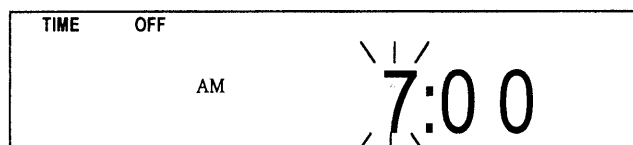

6. Press the **CD-TUNING-SKIP** button to select the timer-off hour.
7. Press the **MEMORY** button again. The hour segment stops flashing, the minute segment flashes.

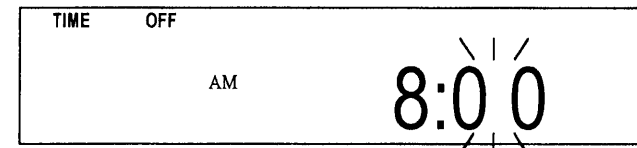

8. Press the **CD-TUNING-SKIP** button to select the timer-off minute.
9. Press the **MEMORY** button to conclude the setting process. Press **MODE / REMAIN** button for "Timer Check" readout appears the "on" and "off" times on the LCD.
10. Press **TIMER** button once for timer operation. To disable timer operation, press the **TIMER** button again. On and off settings will still be kept in memory for future occasions when timer operation is desired. (Press the **TIMER** button again to activate.)

NOTE: The timer will turn on the function last used as follows:

- Previously selected radio station
- CD- track 1

TIMER OPERATION

SureWake function

This feature lets you adjust the night-time listening volume as low or high as desired without affecting the wake-up volume. In the morning, SureWake starts the music quietly and then increases it to room-filling volume to make sure you are awake.

1. Activate the timer as described in the previous section.
2. Press down the **SUREWAKE** button, surewake indicator lit.
3. To de-activate SureWake, press to release the button.

Sleep-to-music function

1. Press the **SLEEP** button. "90" displays on LCD.

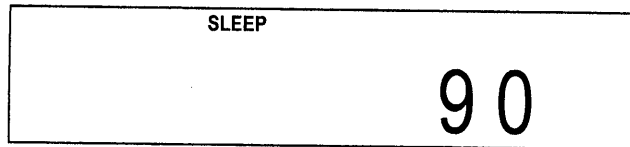

The system will remain on for 90 minutes, then turn off automatically.

2. To decrease the time in 10-minute- increments, press the **SLEEP** button and hold until the desired time appears.
3. The SLEEP time will keep about 3 seconds, then go back to original display.

VOLUME CONTROL

- Turn the **VOLUME** knob to get a satisfactory sound level when you select the desired program.
- In **SUREWAKE** mode, within 10 seconds the volume will gradually increase to a room-filling level. After that, use the **VOLUME** knob on the unit or the remote control to set the volume as desired.

Snooze Function

When the system turns on at the preset time, you can turn off the sound temporarily by pressing the SNOOZE button. The sound will come on again after 9 minutes.

Note: The SNOOZE function can be activated at anytime. If you activate the snooze function accidentally, you can restore normal operation by turning the power off, then on again.

TROUBLESHOOTING

Before requesting service, check the chart below for a possible cause of the problem you are experiencing. Some simple checks or a minor adjustment on your part may eliminate the problem and restore proper operation.

If you are in doubt about some of the check points, or if the remedies indicated in the chart do not solve the problem, please consult your dealer for instruction.

Problem	Checkpoint	Remedy
No operation	<ol style="list-style-type: none"> 1. Is the AC plug connected? Are the batteries dead? 2. Is the desired mode selected? 3. Is the disc inserted correctly? Is the compartment closed? 4. Is the CD lens dirty? 	<ol style="list-style-type: none"> 1. Reconnect the AC plug or reinstall the batteries properly. Change the batteries. 2. Press the desired function button. 3. Insert the disc correctly and close the compartment lid securely. 4. Clean the CD lens or tape heads.
No display	<p>Is the AC plug connected? Are fresh batteries installed?</p>	Reconnect the AC plug or replace the batteries.
No sound	<ol style="list-style-type: none"> 1. Are the speakers connected? 2. Is the headphone plugged in firmly? 3. Is the Snooze function activated? 	<ol style="list-style-type: none"> 1. Check the speaker connections. 2. Insert the headphone plug into the phone jack firmly. 3. Turn the power off, then on again.
Noise or weak radio reception	Is the FM antenna connected?	Rotate the unit for better reception (AM), move the FM antenna wire for better reception (FM).
Volume goes up Automatically	Is the <i>Sure Wake</i> function off?	Make sure the <i>Sure Wake</i> indicator is off. See page 16.

SPECIFICATIONS

FM Frequency Range	87.5MHz~107.9 MHz / 200kHz Step
AM Frequency Range	530kHz~1710kHz / 10 kHz Step
Power Supply (Main Unit)	AC120V, 60Hz DC 12V, 8 "C" size Batteries (UM2 x 8PCS)
Power Supply (Remote Control)	DC 3V, 2 "AA" size Batteries (UM3 x 2 PCS)

Fisher AUDIO MODEL SLIM-1500 LIMITED WARRANTY

OBLIGATIONS

In order to obtain factory warranty service, call the toll-free number below. The unit must be packed in the original carton or a well padded sturdy carton in order to avoid shipping damage. **Note:** Do not return this unit to the retail store for service.

To obtain factory warranty service, product operation or for problem resolution, call

Customer Information 1-800-421-6382
Weekdays 8:00 AM - 5:00 PM Pacific Time

THIS WARRANTY IS VALID ONLY ON FISHER PRODUCTS PURCHASED AND USED IN THE UNITED STATES OF AMERICA.

THIS WARRANTY APPLIES ONLY TO THE ORIGINAL RETAIL USER, AND DOES NOT APPLY TO PRODUCTS USED FOR ANY INDUSTRIAL, PROFESSIONAL OR COMMERCIAL PURPOSE. THE ORIGINAL DATED BILL OF SALE OR SALES SLIP MUST BE SUBMITTED AT THE TIME WARRANTY SERVICE IS REQUESTED.

Subject to the OBLIGATIONS above and EXCLUSIONS below, SANYO FISHER COMPANY (SFC) warrants this FISHER product against defects in materials and workmanship for the periods of LABOR and PARTS specified below. SFC will repair or replace (at its option) the product and any of its parts which fail to conform to this warranty with new or reconditioned products or parts. The warranty period commences on the date the product was first purchased at retail.

LABOR	PARTS
90 DAYS	90 DAYS

EXCLUSIONS

This warranty does not cover (A) the adjustment of customer-operated controls as explained in the appropriate model's instruction manual, or (B) the repair of any product whose serial number has been altered, defaced or removed.

This warranty shall not apply to the cabinet or cosmetic parts, antenna, knobs, batteries or routine maintenance.

This warranty does not apply to uncrating, setup, installation, removal of the product for repair or reinstallation of the product after repair.

This warranty does not apply to repairs or replacements necessitated by any cause beyond the control of SFC including, but not limited to, any malfunction, defect or failure caused by or resulting from unauthorized service or parts, improper maintenance, operation contrary to furnished instructions, shipping or transit accidents, modification or repair by the user, abuse, misuse, neglect, accident, incorrect power line voltage, fire, flood or other Acts of God, or normal wear and tear.

The foregoing is in lieu of all other expressed warranties and SFC does not assume or authorize any party to assume for it any other obligation or liability.

THE DURATION OF ANY WARRANTIES WHICH MAY BE IMPLIED BY LAW (INCLUDING THE WARRANTIES OF MERCHANTABILITY AND FITNESS) IS LIMITED TO THE TERM OF THIS WARRANTY. IN NO EVENT SHALL SFC BE LIABLE FOR SPECIAL, INCIDENTAL OR CONSEQUENTIAL DAMAGES ARISING FROM OWNERSHIP OR USE OF THIS PRODUCT, OR FOR ANY DELAY IN THE PERFORMANCE OF ITS OBLIGATIONS UNDER THIS WARRANTY DUE TO CAUSES BEYOND ITS CONTROL. SOME STATES DO NOT ALLOW LIMITATIONS ON HOW LONG AN IMPLIED WARRANTY LASTS AND/OR DO NOT ALLOW THE EXCLUSION OR LIMITATION OF CONSEQUENTIAL DAMAGES, SO THE ABOVE LIMITATIONS AND EXCLUSIONS MAY NOT APPLY TO YOU. THIS WARRANTY GIVES YOU SPECIFIC LEGAL RIGHTS. YOU MAY HAVE OTHER RIGHTS, WHICH VARY FROM STATE TO STATE.

For your protection in the event of theft or loss of this product, please fill in the information below for your own personal records.

Model No. _____ Serial No. _____
(Located on back or bottom side of unit)
Date of Purchase _____ Purchase Price _____
Where Purchased _____



21605 Plummer Street
Chatsworth, CA 91311
Printed in China

SLIM-1500, Issue Number 1